



# LAGUNA

## Fusion2 mod.2022

### Table Saw

Operating Instructions



**Producer:**

Laguna Tools Inc  
744 Refuge Way, Suite 200  
Grand Prairie, Texas 75050  
USA  
Phone: +1 800-234-1976  
Website: [www.lagunatools.com](http://www.lagunatools.com)

**Distributor:**

IGM nástroje a stroje s.r.o.  
Ke Kopanině 560, 252 67, Tuchoměřice  
Czech Republic, EU  
Phone: +420 220 950 910  
E-mail: [sales@igmtools.com](mailto:sales@igmtools.com)  
Website: [www.igmtools.com](http://www.igmtools.com)



2024-07-11

151-Fusion2 LAGUNA Table Saw Manual EN v3.01.01 A4ob



## EC DECLARATION OF CONFORMITY

We  
(Manufacturer)

Laguna Tools Inc.  
744 Refuge Way, Suite 200, Grand Prairie, TX 75050, USA

Declare that the product name: Table Saw

Model Name: Fusion1. Fusion2 & Fusion3

Conform with the essential safety requirements of the relevant European Directive:  
EC-type Examination Certificate of MD (2006/42/EC) for update standards and additional issue Conformity  
Certificate of LVD (2014/35/EU)

The person who compile technical file established within the EU:

Name: IGM nastroje a stroje s.r.o.

Address: Ke Kopanine 560, Tuchomerice, CZ-252 67

Tel.: +420 220 950 910

Email: [sales@igmtools.com](mailto:sales@igmtools.com)

Mounting and connecting instructions defined in catalogues and technical construction files must be  
respected by the user.

They are based on the following standards:

- EN ISO 19085-1:2021  
Woodworking machines - Safety - Part 1: Common requirements
- EN ISO 19085-9:2020  
Woodworking machines - Safety - Part 9: Circular saw benches (with and without sliding table)

Responsible for the documentation: Head Product Management, Laguna Tools Inc.

Name : Stephen Stoppenbrink / Chief Executive Officer  
Responsibility

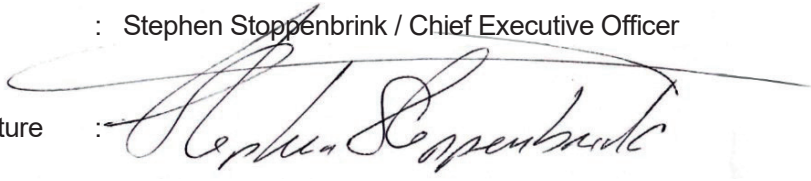
Authorized signature : 

Date : July 1, 2024

Place : Laguna Tools Inc.

In 744 Refuge Way, Suite 200, Grand Prairie, Texas 75050, USA

Telephone: +1 949 474-1200

Fax: +1 949 474-0150



# EN - English

## Operating Instructions (Laguna manual)

Dear Woodworker,

Thank you for your purchase and welcome to the Laguna Tools group of discerning woodworkers. We understand that you have a choice of where to purchase your machines and appreciate the confidence you have in the Laguna Tools brand. Every machine manufactured by Laguna Tools has been carefully designed and well thought through from a woodworker's perspective. Through hands-on experience, Laguna Tools is constantly working hard to make innovative, precision products. Products that inspire you to create works of art, are a joy to run and work on, and encourage your performance.

## Contents

### 1. Declaration of conformity

#### 1.1 Warranty

### 2. About this manual

### 3. Fusion 2 Specifications

#### 3.1 Contents

#### 3.2 Technical

#### 3.3 Main Features

### 4. General Safety

#### 4.1 Intended Use

#### 4.2 Work Area

#### 4.3 Personal Safety

#### 4.4 Tool Use

#### 4.5 Guarding Related Warnings

#### 4.6 Work Related Warnings

#### 4.7 Kickback Causes and Related Warnings

#### 4.8 Table Saw Operating Procedure Warnings

#### 4.9 Electrical

#### 4.10 Noise emissions

#### 4.11 Grounding

#### 4.12 Rulings

#### 4.13 Notice on safe use of the machine

### 5. Machine overview

#### 5.1 Controls

### 6. Setup

#### 6.1 Receiving and unpacking

#### 6.2 Inventory

#### 6.3 Loose parts & overview

#### 6.4 General setup

#### 6.5 Installing/removing the throat plate

#### 6.6 Installing/removing safety accessories

#### 6.7 Installing/removing the blade

### 7. Adjustments

#### 7.1 Fence adjustments

#### 7.2 Table adjustments

#### 7.3 Arbor and tilt adjustments

#### 7.4 Accessory adjustments

#### 7.5 Push block and push stick

### 8. Type of cut

#### 8.1 Ripping

#### 8.2 Bevel ripping

#### 8.3 Ripping small workpieces

#### 8.4 Cross cutting

#### 8.5 Bevel cross cutting

#### 8.6 Mitre cuts

### 9. Maintenance

#### 9.1 Internal Components Map

### 10. Trouble-shooting

## 1. Declaration of conformity

We declare that this product is in compliance with the directive and the standard mentioned on the 2. page of this manual.

### 1.1 Warranty

IGM Tools & Machinery strives to always deliver high-quality machinery. The warranty is governed by the valid terms and conditions of IGM Tools & Machinery available at [www.igmtools.com](http://www.igmtools.com).

## 2. About manual

This manual is intended to thoroughly cover the setup up, maintenance, and proper adjustments of your new purchase. Aside from the proceeding general safety considerations, this manual DOES NOT cover woodworking or metalworking techniques that are possible with this product and the appropriate safety precautions necessary for safe practices. There are several organizations with published safe practices, techniques, and proper operation of this tool. Or look for handy tips and instructions at [www.igmtools.com](http://www.igmtools.com).

## 3. Fusion 2 specifications

### 3.1 Contents

Professional Square Zero Clearance Throat Plate (pre-installed)  
250 mm Saw Blade (pre-installed)  
Riving Knife (pre-installed)  
Mitre Gauge (ships in tool holder)  
Tool Holder (pre-installed)  
Fence  
Blade Guard  
Arbor Wrench  
Installation and Adjustment Tools

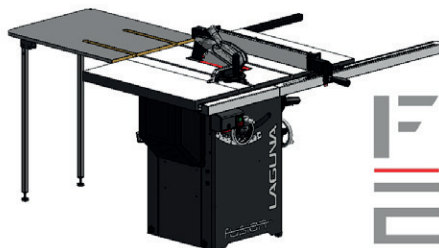

### 3.2 Technical Data

Power	230V / 50 Hz / 1 Phase
Motor Type	TEFC Capacitor Start AC Induction
Power Input	1300 W
Motor Speed	2850 /min-1
Full Load Amperage	7.5 A
Start Capacitor	200 µF-U
Run Capacitor	35 µF-U
Switch Type	Magnetic with Overload Protection
Power Transfer	Single V-Ribbed 142J FJ
Power Cord	2 m / H07RNF
Power Plug Included	CEE 7/7
Breaker Recommendation	13 A,

tripping characteristic C (13/1/C)

### General

Footprint (LxW)	473 x 490 mm
Overall Dimensions (LxWxH)	1663 x 1652 x 1080.9 mm
Shipping Dimensions (LxWxH)	870 x 1190 x 1085 mm
Weight (No Accessories)	155 Kg
Shipping Weight:	200 Kg
Dust Collection: Outlet Dia.	101.6 mm
Dust Collection m3/h, min.	934 m3/h
Sound Emissions	N/A

### Specifics

Blade Diameter	250 mm
Bore Diameter	30 mm
Arbor Speed	3800 /min-1
Blade Rotation	Counter-Clockwise (face arbor)

### Rip Capacity, with Fence

914,4 mm Right (1 320,8 mm w/ accessories)	
Max. Depth of Cut 90°	79 mm
Max. Depth of Cut 45°	56 mm
Blade Tilt	45° Left, 3° Arbor Adjustment
Table Dim., with Extensions (LxW)	1117 mm x 1663 mm

Wing Dimensions (LxW)	792 x 305 mm
Mitre Slot	19 and 23 mm, T-Slot
Fence Type	Sliding Cam Action Fully Adjustable
Fence Dim (LxWxTh.)	670 x 80 x 17 mm
Throat Plate Type	Zero Clearance
Throat Plate (LxWxTh.)	372 x 104.5 x 13 mm
Floor to Table Height	887 mm

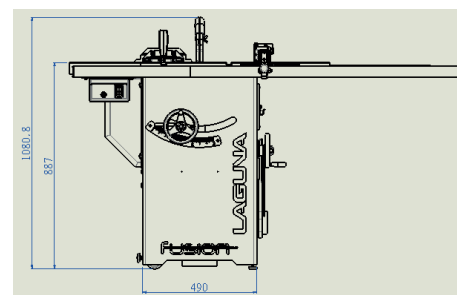
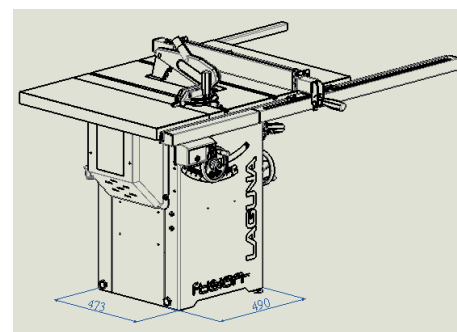

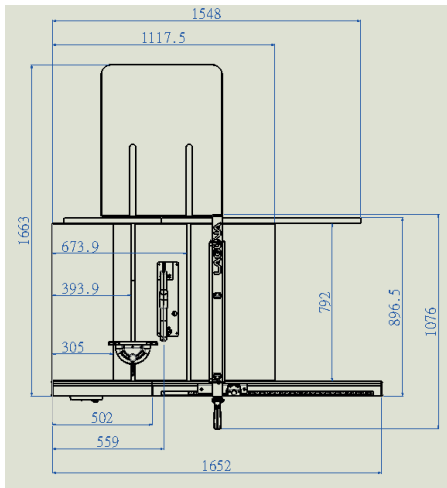

### 3.3 Main Features

- Robust cast-iron trunnion.
- Cast-iron control wheels.
- Two T-slots on the side of the blade.
- Smooth control of the blade height and tilt.
- Lever for a quick blade swap.
- Adjustable control panel.
- Quick clamping riving knife.
- Integrated wheel for simple mobility.
- Includes rear table.

## 4. General Safety

Warning: Read all safety considerations. Failure to follow this set of guidelines can result in unwarranted damage to the machine and serious injury to the operator and bystanders. Save all warnings and instructions for future reference.

### 4.1 Intended Use

• Table saw and the workpiece guide equipment supplied with it are intended to be used exclusively for the following purposes:

- Laminated and non-laminated board materials (e.g. chipboard, coreboard, MDF board,...)
- Solid wood
- Gypsum plasterboard, Cardboard, Veneer with a suitable clamping device
- Dimensionally stable plastics (thermoset plastics, thermoplastics).Sawing these materials does not normally involve any risks in respect of dust, chips, and thermal degradation products.

Tools:

- The chosen saw blade must be suitable both for the specific work cycle and for the specific material.
- Only circular blades made of tungsten carbide and have a diameter of 250 mm, arbor size 30 mm are allowed to be used.
- Saw blades made of high-alloy high-speed steel (HSS) or chrome are not allowed to be used.
- Saw blades and their fixing devices shall conform to EN 847-1:2013.

Site of installation/use:

- The machine is not suitable for use outdoors, or in rooms that are subject to moisture or the risk of explosions.
- The intended use of the machine involves connection to suitable dust collection.
- The intended ambient temperature used of the machine: +10 °C to +35 °C.
- The intended altitude used of the machine : shall be at altitudes up to 1000 m above mean sea level.
- The intended Relative humidity used of the

machine : not exceed 50% at 35°C.

- Intended use also involves compliance with our specified operating, maintenance and repair conditions and the safety information contained in the operating instructions.
- The table saw may only be used, set up and maintained by persons who are familiar with the machine and aware of the dangers.
- The pertinent accident prevention regulations as well as any other generally recognized technical safety and industrial medicine rules must be observed.
- Repair work must be carried out by our own customer service or by an organization that we have authorized. Only original spare parts are allowed to be used for this. we will assume no warranty for any damage that is caused by using non-original spare parts.

Warning: The machine is prohibited to be used in a potentially explosive atmosphere!

### 4.2 Work Area

- Keep all children and untrained persons away from the machine. Do not allow bystanders to touch the machine or power cord. All people but the operator should be away from the work area.
- Keep work area clean and well lit. A cluttered area can limit the range of motion needed by the machine and cause serious injury to the operator or damage to the machine.
- Make sure the work area is child-proof and inaccessible to untrained persons. Use padlocks where possible and keep all machines unplugged when not in use.
- Do not keep or place tools in outdoor, damp, or dangerous environments. Never operate the tool under wet or damp conditions; there is a serious risk of electrical shock. Exposing this product to those environments may result in damage to the tool and operator injury. Do not use tool in the presence of flammable liquids or gasses.
- Do not operate machine in explosive atmospheres, such as in the presence of flammable liquids, gases or dust. Machine create sparks which may ignite the dust or fumes.

### 4.3 Personal Safety

- Stay alert, watch what you are doing and use common sense when operating a power tool. do not use a power tool while you are tired or under the influence of drugs, alcohol or medication. A moment of inattention while operating power tools may result in serious personal injury.
- Use personal protective equipment. always wear eye protection. Protective equipment such as a dust mask, non-skid safety shoes, hard hat or hearing protection used for appropriate conditions will reduce personal injuries.
- Prevent unintentional starting. Ensure the switch is in the off-position before connecting to power source and/or battery pack, picking up or carrying the tool. Carrying power tools with your finger on the switch or energizing power tools that have the switch on invites accidents.
- Remove any adjusting key or wrench before turning the power tool on. A wrench or a key left attached to a rotating part of the power tool may result in personal injury.
- Do not overreach. Keep proper footing and balance at all times. This enables better control of the power tool in unexpected situations.
- Dress properly. do not wear loose clothing or jewellery. Keep your hair and clothing away from

moving parts. Loose clothes, jewellery or long hair can be caught in moving parts.

- If devices are provided for the connection of dust extraction and collection facilities, ensure these are connected and properly used. Use of dust collection can reduce dust-related hazards.
- Do not let familiarity gained from frequent use of tools allow you to become complacent and ignore tool safety principles. A careless action can cause severe injury within a fraction of a second.
- Know your machine. Read and understand the owner's manual and labels affixed to the tool. Learn its application and limitations as well as the specific potential hazards peculiar to this tool.
- Use safety goggles. Some machines require additional face shielding than offered by safety goggles alone. Know your machine and the proper PPE to use.
- Use ear protection. Some machines operate at very high noise levels. To prevent harm, be sure to use ear protection always.
- Guard against electric shock. Prevent all bodily contact with grounded surfaces and parts of the machine that pose electrical threats.
- Avoid accidental starting for machines without magnetic or automatic shut-off switches. Make sure the tool is in the off position prior to plugging it in.
- Keep guards in place. Machine parts like riving knives, blade guard, cutter-head guards, feather boards, push sticks, etc. are designed to minimize possible injury. Keep those parts in place unless a safer means of operation is available.

• Be alert always and give 100% of your attention to the operation of this tool. Failure to do so can result in serious injury to both the operator and bystanders.

• Do not rely on guards. The operator of this tool is 100% responsible for his/her own safety. The guards and safety components sold with this machine are not enough to ensure safety.

• Check for damaged parts. Before every use of this tool, makes sure the machine and any components of the machine are not damaged or at the risk of being damaged. If a damaged part is discovered, stop immediately and put the machine out of service until the part is replaced.

Warning: All repairs should be done by trained repairmen. Contact your supplier or a competent repair service.

Warning: Use only supplier Tools or compatible and marked replacement parts. All others may cause damage or harm.

Warning: Use only manufacturer-recommended accessories. Some accessories may cause damage or harm.

### 4.4 Tool Use

- Do not force the power tool. use the correct power tool for your application. The correct power tool will do the job better and safer at the rate for which it was designed.
- Do not use the power tool if the switch does not turn it on and off. Any power tool that cannot be controlled with the switch is dangerous and must be repaired.

- Disconnect the plug from the power source and/or remove the battery pack, if detachable, from the power tool before making any adjustments, changing accessories, or storing power tools. Such preventive safety measures reduce the risk of starting the power tool accidentally.
- Store idle power tools out of the reach of children and do not allow persons unfamiliar with the power tool or these instructions to operate the power tool. Power tools are dangerous in the hands of untrained users.
- Maintain power tools and accessories. Check for misalignment or binding of moving parts, breakage of parts and any other condition that may affect the power tool's operation. If damaged, have the power tool repaired before use. Many accidents are caused by poorly maintained power tools.
- Keep cutting tools sharp and clean. Properly maintained cutting tools with sharp cutting edges are less likely to bind and are easier to control.
- Use the power tool, accessories and tool bits etc. in accordance with these instructions, taking into account the working conditions and the work to be performed. Use of the power tool for operations different from those intended could result in a hazardous situation.
- Keep handles and grasping surfaces dry, clean and free from oil and grease. Slippery handles and grasping surfaces do not allow for safe handling and control of the tool in unexpected situations.
- Use proper speed. A machine will do a better and safer job when operated at the proper speed.
- Use the correct tool for the job. Know the limitations and capabilities of your new purchase. Do not try to "fit a square peg in a round hole."
- Secure the work piece. For all woodworking and metalworking applications, the workpiece should be secured correctly by the operator using appropriate clamps and vises. Always use a clamp or vise when available — it is safer than using your hands.
- Feed direction. If feed rate is applicable, then there is only one direction of feed rate for the tool. Do not force the workpiece in the wrong feed direction.
- Never leave tool running unattended. Do not leave the tool until it comes to a complete stop. When unattended, unplug the tool.
- Maintain tools with care. Keep cutting tools sharp and clean for better and safer performance.
- Follow instruction for lubricating and changing accessories. Inspect tool cords periodically and if damaged have them repaired by an authorized service facility. Inspect extension cords periodically and replace if damaged. Keep hand dry, clean and free from oil and grease.
- Illumination. Adequate general or localized lighting shall be provided.
- Dust Collection. During use the saw benches shall be connected to an external chip and dust extraction system.

#### 4.5 Guarding related warnings

- Keep guards in place. Guards must be in working order and be properly mounted.

A guard that is loose, damaged, or is not functioning correctly must be repaired or replaced.

- Always use saw blade guard and riving knife for every through-cutting operation. For through-cutting operations where the saw blade cuts completely through the thickness of the workpiece, the guard and other safety devices help reduce the risk of injury.
- Make sure the saw blade is not contacting the guard, riving knife or the workpiece before the switch is turned on. Inadvertent contact of these items with the saw blade could cause a hazardous condition.
- Adjust the riving knife as described in this instruction manual. Incorrect spacing, positioning and alignment can make the riving knife ineffective in reducing the likelihood of kickback.
- For the riving knife to work, it must be engaged in the workpiece. The riving knife is ineffective when cutting workpieces that are too short to be engaged with the riving knife. Under these conditions a kickback cannot be prevented by the riving knife.
- Use the appropriate saw blade for the riving knife. For the riving knife to function properly, the saw blade diameter must match the appropriate riving knife and the body of the saw blade must be thinner than the thickness of the riving knife and the cutting width of the saw blade must be wider than the thickness of the riving knife.

#### 4.6 Work related warnings

- Danger: never place your fingers or hands in the vicinity or in line with the saw blade. A moment of inattention or a slip could direct your hand towards the saw blade and result in serious personal injury.
- Feed the workpiece into the saw blade or cutter only against the direction of rotation. Feeding the workpiece in the same direction that the saw blade is rotating above the table may result in the workpiece, and your hand, being pulled into the saw blade.
- Never use the mitre gauge to feed the workpiece when ripping and do not use the rip fence as a length stop when cross cutting with the mitre gauge. Guiding the workpiece with the rip fence and the mitre gauge at the same time increases the likelihood of saw blade binding and kickback.
- When ripping, always apply the workpiece feeding force between the fence and the saw blade. Use a push stick when the distance between the fence and the saw blade is less than 150 mm, and use a push block when this distance is less than 50 mm. Work helping devices will keep your hand at a safe distance from the saw blade.
- Use only the push stick provided by the manufacturer or constructed in accordance with the instructions. This push stick provides sufficient distance of the hand from the saw blade.
- Never use a damaged or cut push stick. A damaged push stick may break causing your hand to slip into the saw blade.
- Do not perform any operation "freehand". Always use either the rip fence or the mitre gauge to position and guide the workpiece. "Freehand" means using your hands to support or guide the workpiece, in lieu of a rip fence or mitre gauge. Freehand sawing leads to

misalignment, binding and kickback.

- Never reach around or over a rotating saw blade. Reaching for a workpiece may lead to accidental contact with the moving saw blade.
- Provide auxiliary workpiece support to the rear and/or sides of the saw table for long and/or wide workpieces to keep them level. A long and/or wide workpiece has a tendency to pivot on the table's edge, causing loss of control, saw blade binding and kickback.
- Feed workpiece at an even pace. Do not bend or twist the workpiece. If jamming occurs, turn the tool off immediately, unplug the tool then clear the jam. Jamming the saw blade by the workpiece can cause kickback or stall the motor.
- Do not remove pieces of cut-off material while the saw is running. The material may become trapped between the fence or inside the saw blade guard and the saw blade pulling your fingers into the saw blade. Turn the saw off and wait until the saw blade stops before removing material.
- Use an auxiliary fence in contact with the table top when ripping workpieces less than 2 mm thick. A thin workpiece may wedge under the rip fence and create a kickback.

#### 4.7 Kickback causes and related warnings

- Never stand directly in line with the saw blade. Always position your body on the same side of the saw blade as the fence. Kickback may propel the workpiece at high velocity towards anyone standing in front and in line with the saw blade.
- Never reach over or in back of the saw blade to pull or to support the workpiece. Accidental contact with the saw blade may occur or kickback may drag your fingers into the saw blade.
- Never hold and press the workpiece that is being cut off against the rotating saw blade. Pressing the workpiece being cut off against the saw blade will create a binding condition and kickback.
- Align the fence to be parallel with the saw blade. A misaligned fence will pinch the workpiece against the saw blade and create kickback.
- Use extra caution when making a cut into blind areas of assembled workpieces. The protruding saw blade may cut objects that can cause kickback. Note, the above safety warning only applies to tools where such cuts are permitted by design and instruction.
- Support large panels to minimise the risk of saw blade pinching and kickback. Large panels tend to sag under their own weight. Support(s) must be placed under all portions of the panel overhanging the table top.
- Use extra caution when cutting a workpiece that is twisted, knotted, warped or does not have a straight edge to guide it with a mitre gauge or along the fence. A warped, knotted, or twisted workpiece is unstable and causes misalignment of the kerf with the saw blade, binding and kickback.
- Never cut more than one workpiece, stacked vertically or horizontally. The saw blade could pick up one or more pieces and cause kickback.
- When restarting the saw with the saw blade in the workpiece, centre the saw blade in the kerf so that the saw teeth are not engaged in the material. If the saw blade binds, it may lift

up the workpiece and cause kickback when the saw is restarted.

- Keep saw blades clean, sharp, and with sufficient set. Never use warped saw blades or saw blades with cracked or broken teeth. Sharp and properly set saw blades minimise binding, stalling and kickback.

#### 4.8 Table saw operating procedure warnings

- Turn off the table saw and disconnect the power cord when removing the table insert, changing the saw blade or making adjustments to the riving knife or saw blade guard, and when the machine is left unattended. Precautionary measures will avoid accidents.
- Never leave the table saw running unattended. Turn it off and don't leave the tool until it comes to a complete stop. An unattended running saw is an uncontrolled hazard.
- Locate the table saw in a well-lit and level area where you can maintain good footing and balance. It should be installed in an area that provides enough room to easily handle the size of your workpiece. Cramped, dark areas, and uneven slippery floors invite accidents.
- Frequently clean and remove sawdust from under the saw table and/or the dust collection device. Accumulated sawdust is combustible and may self-ignite.
- The table saw must be secured. A table saw that is not properly secured may move or tip over.
- Remove tools, wood scraps, etc. From the table before the table saw is turned on. Distraction or a potential jam can be dangerous.
- Always use saw blades with correct size and shape (diamond versus round) of arbour holes. Saw blades that do not match the mounting hardware of the saw will run off-centre, causing loss of control.
- Never use damaged or incorrect saw blade mounting means such as flanges, saw blade washers, bolts or nuts. These mounting means were specially designed for your saw, for safe operation and optimum performance.
- Never stand on the table saw, do not use it as a stepping stool. Serious injury could occur if the tool is tipped or if the cutting tool is accidentally contacted.
- Make sure that the saw blade is installed to rotate in the proper direction. Do not use grinding wheels, wire brushes, or abrasive wheels on a table saw. Improper saw blade installation or use of accessories not recommended may cause serious injury.

#### 4.9 Electrical

- Machine plugs must match the outlet. Never modify the plug in any way. Do not use any adapter plugs with earthed (grounded) power tools. Unmodified plugs and matching outlets will reduce risk of electric shock.
- Disconnect the power first. Always disconnect machine from power supply before adjusting, changing tooling, or servicing machine.
- Power supply: 230V/50Hz/1 phase.
- Use a qualified electrician for all electrical connections. Failure to do so may result in damage to the tool and electrical shock to the operator and bystanders.
- Power plugs. Your machine may not come

with a power plug because of the variance in power receptacles. Consult with a local electrician prior to purchasing a power plug. Do not abuse the cord. Never use the cord for carrying, pulling or unplugging the power tool. Keep cord away from heat, oil, sharp edges or moving parts. Damaged or entangled cords increase the risk of electric shock.

- Extension cords. Consult with or use a qualified electrician prior to sizing extension cords for use with this machine.
- When operating a power tool outdoors, use an extension cord suitable for outdoor use. Use of a cord suitable for outdoor use reduces the risk of electric shock.
- If operating a power tool in a damp location is unavoidable, use a residual current device (rcd) protected supply.
- Electrical protection. End user should connect the machine to a circuit protected with a 16 A circuit breaker, tripping characteristic C (16/1/C) and overvoltage protection.

#### 4.10 Noise emissions

• **Reference standards.**  
The measurements of noise emission were conducted according to the EN ISO 11202:2010 for the determination of sound pressure level at the operation positions. When the measured sound pressure levels at the operation positions exceed 80db(a), the measurements of sound power levels were conducted according to EN ISO 3746:2010.

• **Operating conditions.**  
The operating conditions for noise measurement comply with Annex A of ISO 7960:1995.

• **Testing results:**  
A-weighted Sound Pressure - Level 91.3 dB  
A-weighted Sound Power - Level 113.8 dB  
Associated uncertainty - K=4dB  
Background noise of measurement surrounding is - 55dB

The figures quoted are emission levels and are not necessarily safe working levels. Whilst there is a correlation between the emission and exposure levels, this cannot be used reliably to determine whether or not further precautions are required. Factors that influence the actual level of exposure of the workforce include the characteristics of the work room, the other sources of noise etc. i.e. the number of machines and other adjacent processes. Also the permissible exposure level can vary from country to country. This information, however, will enable the user of the machine to make a better evaluation of the hazard and risk.

#### 4.11 Grounding

- Proper grounding of your machines lowers the risk of injury by electricity.
- Avoid body contact with earthed or grounded surfaces, such as pipes, radiators, ranges and refrigerators. There is an increased risk of electric shock if your body is earthed or grounded.
- Do not modify the plug. Do not remove any of the prongs attached to the proper plug for the machine.
- Use only 3-wire extension cords. Some extension cords only have two wires, which does not allow for grounding.
- Always use grounded connections and work only on a grounded circuit.

#### 4.12 Rulings

Warning: Before connecting this tool to a power supply (receptacle, outlet, etc.) Make sure that the voltage supplied is the same that is specified on the nameplate of the tool. Also make sure that the power supply is equipped with the appropriate breaker and plug according to your local electrical code. If in doubt, do not plug in the machine. Using this tool with a voltage different than that stated on the nameplate can damage the electrical components of this machine and any such damage will not be covered by a warranty.

Warning: Some dust created by power sanding, sawing, grinding, drilling and other construction activities contains chemicals known to cause cancer, birth defects or other reproductive harm. Some examples of these chemicals are:

- Lead from lead-based paint.
- Crystalline silica from bricks, cement, and other masonry products.
- Arsenic and chromium from chemically treated lumber.

Your risk of exposure varies, depending on how often you do this type of work. To reduce your exposure to these chemicals, work in a well-ventilated area and work with approved safety equipment, such as face or dust masks that are specifically designed to filter out microscopic particles.

#### 4.13 Notice on safe use

The machinery sold by Laguna Tools, distributed by IGM Tools and machinery co., are safe when used properly and comply to with the CE norms, standards and regulations for safe use. Laguna Tools or IGM is in no way responsible for injury or death that occurs while using this product. Your personal safety is 100% your responsibility and using this product requires 100% of your attention. If there is any concern related to the application you are intending to use this tool for, DO NOT proceed until you have contacted the retailer you purchased it from and have been advised on the correct application of the product. This manual is intended to thoroughly cover the setup up, maintenance, and proper adjustments of your new purchase. Aside from the proceeding general safety considerations, this manual DOES NOT cover woodworking or metalworking techniques that are possible with this product and the appropriate safety precautions necessary for safe practices. There are several organizations with published safe practices, techniques, and proper operation of this tool.



Warning  
The symbols below advise that you follow the correct safety procedures when using this machine.



Keep your fingers away from the saw blade



Environmental protection:  
Waste electrical products should not be disposed of with household waste. Please recycle where facilities exist. Check with your local Authority or retailer for recycling advice.



Dusk mask should be worn.



Eye protection should be worn.



Ear protection should be worn.



Disconnect from power supply before servicing



Fully read manual and safety instructions before use.



Safety gloves should be worn.

## 5. Machine Overview

1. Start / Stop
2. Rip Fence
3. Fence Front guide
4. Fence Rear guide
5. Table with mitre slots
6. Cabinet with integrated mobility kit
7. Arbor height adjustment control
8. Arbor tilt adjustment control
9. Dust extraction outlet
10. Motor cover
11. Throat plate
12. Blade
13. Blade guard
14. Riving knife
15. Arbor wrench
16. Push stick
17. Mitre gauge

### 5.1 Controls Start/Stop/Fuse

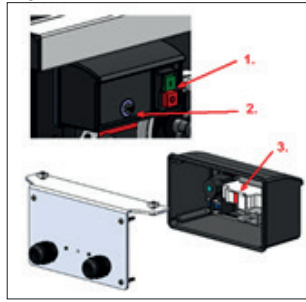

1. Magnetic switch
2. Overload protector
3. Fuse

CAUTION: Always turn off and unplug the machine before changing the fuse.

### Arbor height control

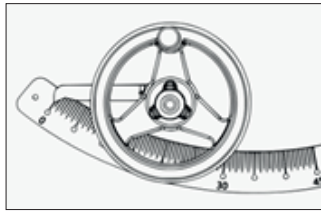

The arbor height control adjusts the height of the blade. Centred in the control is the height adjustment lock. Behind the control is the tile gauge. CW to raise, CCW to lower blade.  
CAUTION: DO NOT ADJUST HEIGHT WHEEL WHEN LOCKED.

### Arbor tilt control

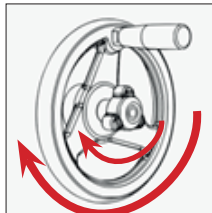

The tilt control, located on the right of the cabinet, adjusts the tilt of the arbor. Centre is the tilt lock. CW to tilt left, CCW to tilt the blade

to the right.  
CAUTION: DO NOT ADJUST TILT WHEEL WHEN LOCKED.

### Fence clamp lock

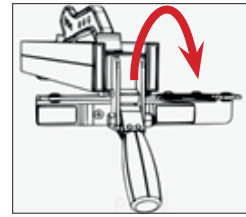

The fence clamp securely locks the fence anywhere on the rail by a cam action mechanism.

## 6. Setup

Use Caution: Your new Laguna Tools machine is heavy. Use a minimum of two people when lifting the tool into position and moving the tool into position.

Warning: DO NOT connect to a power supply until the setup is complete. DO NOT perform any of the following steps, installations, or adjustments with the saw connected to the power source.

Warning: To avoid set-up problems, to prevent potential damage to the machine and personal injury, read through the entire setup section prior to setting up the machine.

### 6.1 Receiving and unpacking

If any damage has occurred because of shipment, note the damage on the bill of lading or refuse the shipment. Immediately call the dealer store where the machine was purchased.

TRANSPORTATION AND STORAGE. The measures of anti-rust and shockproof should be taken during packing. The machine endures transportation and store in -25~55°C ambient temperature.

Be careful not to expose the machine to rain or damage when transporting or storing.

**While transporting or handling the machine, be careful and let the activity be done by qualified personnel especially trained for this kind of activity!**

**While the machine is being loaded or unloaded, make sure that no person or subject gets pressed by the machine!**

**Select proper transportation device according to the weight of the machine. Make sure the lifting capacity of transportation device is competent for the weight of the machine.**

TRANSPORTATION BEFORE UNPACKING  
As standard, the machine is packed in a robust wooden box. Pic.10 shows the tool that can be used to transport the packaging.



### UNPACKING

1. Receive your table saw.
2. Unscrew the crate fasteners.
3. Lift crate off pallet.
4. Check Inventory.
5. Wipe off protective oils.

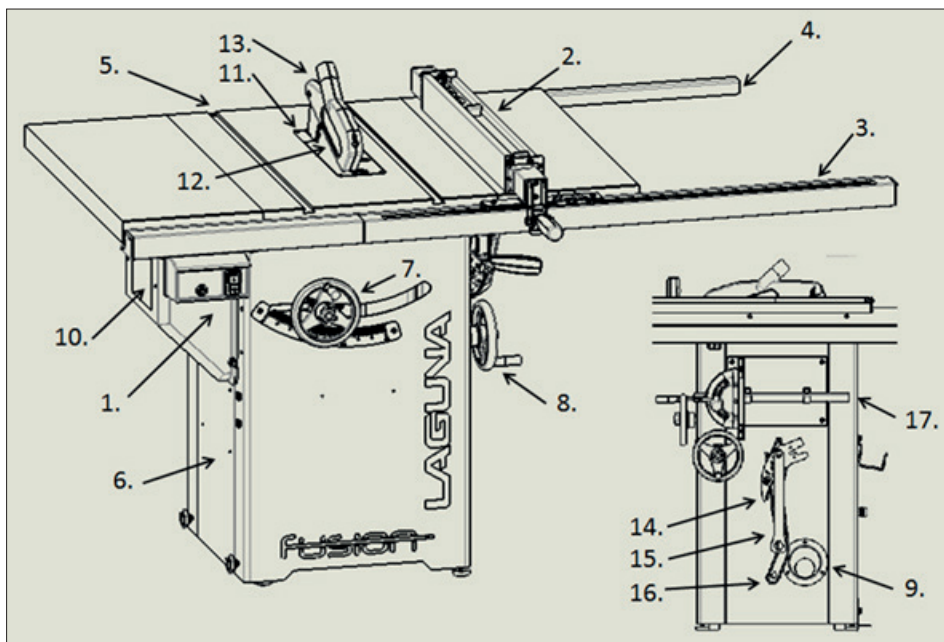

## Receiving your table saw



This is how machine is shipped from the factory.

## Unscrew the crate fasteners



Use a drill with a #2 Phillips head bit and remove the bottom screws from carton. These screws may be discarded.

## Lift crate off pallet



Use two persons to lift the carton away from the pallet. There should be three packages along with the table saw.

NOTE: The throat plate, riving knife, and 10" blade is pre-installed in the machine. The miter gauge, and blade changing tool are positioned in the tool holder located on the right side of the cabinet.

## Check Inventory



1. Fence, install tools, push stick, blade guard assembly
2. Smaller fence rail sections, hardware kit
3. Longer fence rail sections.

## Wipe off protective plastics

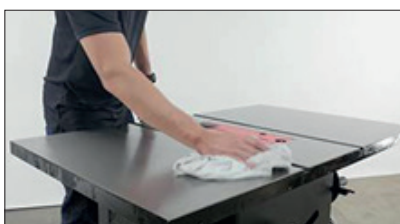

Peel back the protective vinyl plastic and wipe

away the oil with a waste rag.

Use Caution: An oily rag can be a serious fire hazard. Discard in an appropriate manner.

Tech Tip: To help keep your table top clean and to prevent or clean any rust, we recommend waxing your tabletop with an appropriate wax rubbing compound. This will also reduce friction under operation. Rust can be removed with WD-40.

## 6.2 Inventory

Box 1

Fence: PTSF236110175-0130-1-1

Push stick: PTSF236110175-0130-130

Blade guard: PTSF236110175-01302-1

Install Tools

Fence hooks\*: PTSF236110175-0130-118

\* Fence storage hooks may be pre-installed.

Box 2

Rear Rail 2: PTSF236110175-0130-127.5

Front Rail 2: PTSF236110175-0130-127.6

Hardware kit

Box 3

Rear rail 1: PTSF236110175-0130-127.5

Front rail 1: PTSF236110175-0130-127.6

Pre-installed on machine

Throat plate PTSF236110175-0130-6

Riving knife PTSF236110175-0130-27

250mm blade PTSF236110175-0130-33

Mitre gauge PTSF236110175-0130-3

Arbor wrench PTSF236110175-0130-137

Tool storage PTSF236110175-0130-120

Wings (2x) PTSF236110175-0130-4

Note: The front rail part number is comprised of two pieces – both long and short. The rear rail part number is comprised of two pieces – long and short.

Note.: For safety reasons, this machine is not sold with a tape-rule for the left side of the blade. It is not a missing part.

## 6.3 Loose Parts & Overview

Your new machine has been mostly assembled at the certified ISO 91001 factory where it was made. Some parts must be assembled by the purchaser. Please read all steps first before proceeding with step one.

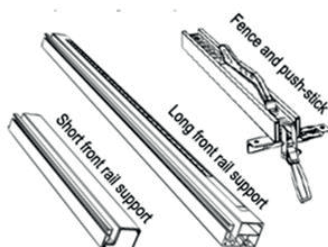
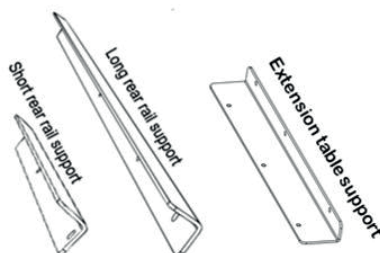

## Blade Guard

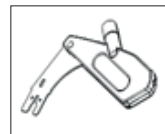

- 5) M8x1.5+ lock washer + washer + nut

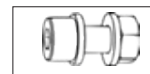

- (5) Square head 8x1.5 + washer + nut



Fence hooks (step 2)

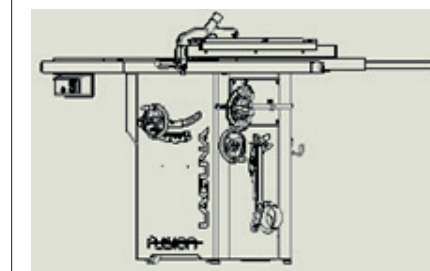
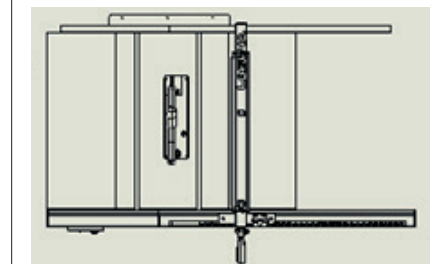
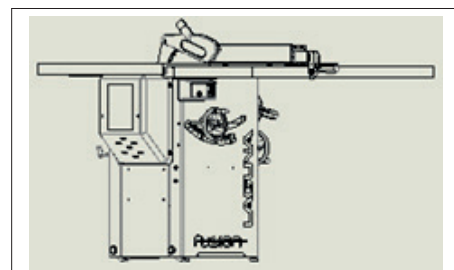
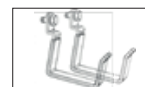

## 6.4 General Setup

1. Attach the short rear fence support
2. Attach the long rear fence support
3. Level the rear rails and fasten
4. Attach T-Slot bolts to front table
5. Insert long front rail fence support
6. Insert short front rail and switch
7. Join front fence supports
8. Align the entire front rail to blade mark
9. Level and fasten the front rail
10. Insert fence
11. Level the saw by adjusting casters

1. Attach short rear fence support  
Use the supplied wrench and Alan key to loosely fasten (2) bolts, lock washers, washers,



and nuts to the short rear fence guide and the back left of the table. **STOP BEFORE TIGHTENING:** Keep bolts loose until entire rail assembly is in place to properly level rail.

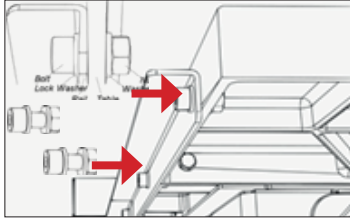

**2. Attach short rear fence support**  
Repeat step 1 for the longer rear fence section with (3) bolts, lock washers, washers, and nuts. Use the same assembly diagram in Step 1. **NOTICE:** If the fence hooks are not yet installed, now is a good time to do so.

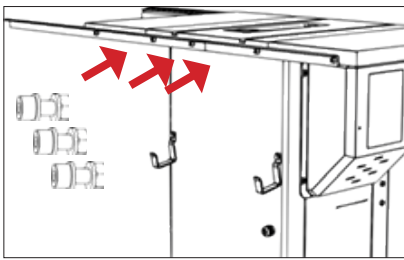

**3. Attach short rear fence support**  
To level the rear fence with the table top, place a rigid straight edge on top of the rails. Apply downward force at both arrow indicators and simultaneously tighten the bolts with the supplied Allen key and wrench.

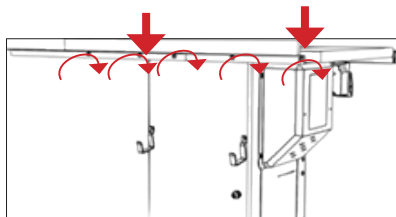

**4. Attach T-slot bolts to front table**  
Loosely fasten the (5) square headed bolts, (5) washers, and (5) nuts. A couple revolutions of the bolt will be tight enough. Prepare to insert the (2) aluminium front rail sections.

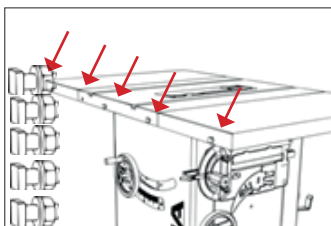

**5. Insert the long front fence support**  
Insert the long Front Rail. **STOP BEFORE TIGHTENING:** Keep these bolts loose until the entire rail assembly is in place to properly level the rail.

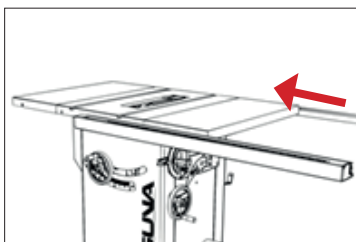

**6. Insert short rail and switch**  
Insert the short front rail into the first square head bolt. **IMPORTANT:** Insert the switch assembly before joining the two front rail

pieces. **STOP BEFORE TIGHTENING.**

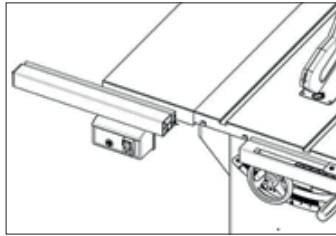

**7. Join front fence supports**  
Align the pins and join the two front rail pieces and firmly push together.

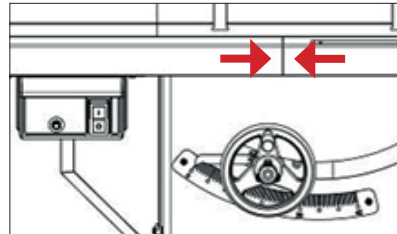

**8. Align the front rail with blade**  
Using the blade notching on the measuring tape, align the entire front rail section to the blade.

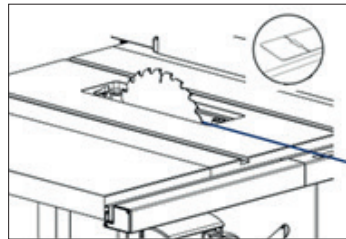

**9. Level and fasten front rail**  
To level the front rail sections to the table top, use a ridged straight edge atop the loosely fit rail sections. Apply downward force to the straight edge while keeping the two sections firmly together. Simultaneously fasten down the bolts.



**10. Install the fence**  
Install the fence by placing the front end first. Be sure that the handle is in the open, unlocked, position prior to installing.



**11. Level the table saw with casters and fix**  
Level the table saw with the ground and fix the machine on the floor with screws.

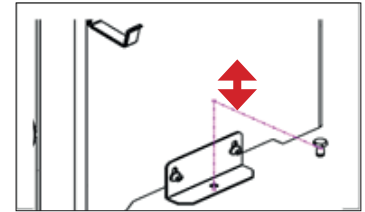

**6.5 Installing/removing the throat plate**

1. Unplug the table saw!
2. Insert the throat plate back end first.
3. Lower the throat plate to the table.
4. Lock the throat plate with the thumb-lock.
5. Level the throat plate with the table using the cat screws.

**Note:** This machine is shipped with a zero-clearance throat plate that has already been cut at the factory. Because of this, there may be some residue already in the saw.

**Installing the throat plate**

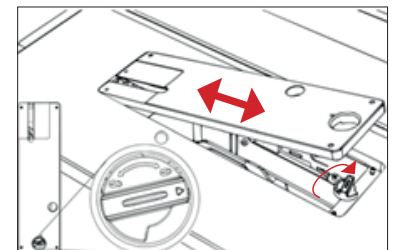

**WARNING: MAKE SURE SAW IS UNPLUGGED.** To remove or install the throat plate, first set it to the unlock position. Then, insert the rear end first and tilt the other end down into position.

**Levelling the throat plate**

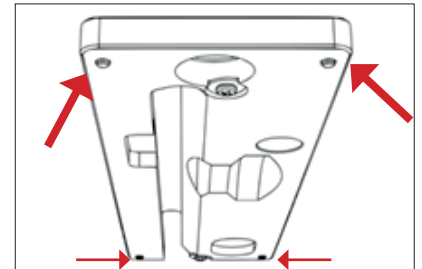

To level the throat plate, adjust the leveling screws.  
**Note:** Make sure the throat plate is lower than the cast iron table. Having the throat plate higher at any position can interfere with the workpiece feed and cause injury or harm and increase the chance of kickback

**6.6 Installing/removing safety accessories**

- A: Saw blade
- B: Riving knife housing
- C: Cam action lever
- D: Riving knife
- E: Blade guard
- F: Blade compliant markings

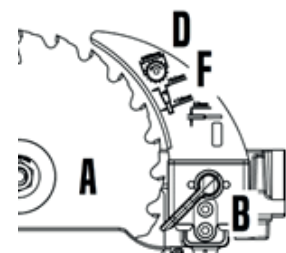

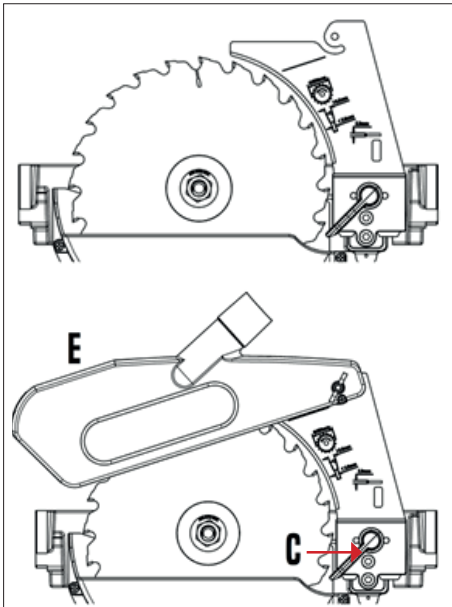

• Note on the Riving Knife

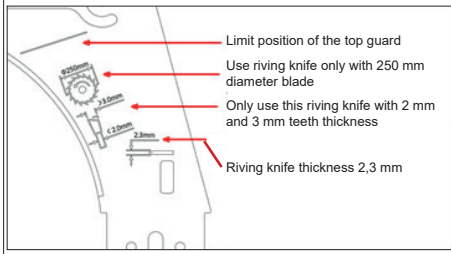

Since Riving Knife, other than those offered by Laguna, has not been tested with this product, use of such accessories with this tool could be hazardous. To reduce the risk of injury, only Laguna, recommended accessories should be used with this product.

• Note on the saw blade

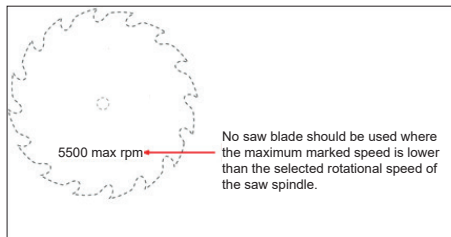

### Installing/removing the riving knife

1. Unplug the table saw!
2. Make sure the lock is in open position
3. Insert the blade guard
4. Position the guard insert
5. Lock the blade guard
6. Reinstall throat plate

CAUTION: Make sure the blade guard is in line with the blade. If it is not in line, please see the Adjustment section.

3. Insert the blade guard



WARNING: MAKE SURE SAW IS UNPLUGGED.

With the throat plate removed, and the cam lock mechanism in the open position (pulled up), insert the blade guard insert into the slot.

4. Position to the left of the casing



Make sure the guard is positioned correctly and seated in the bottom of the casing. Grasp the pawls with one hand, leaving the other hand free to activate the cam action lock.

5. Lock the blade guard



Keep firm hold of the blade guard with left hand and engage the cam lock with the thumb of your right hand.

6. Reinstall the throat plate



Grasp the pawls up and out of the way to reinsert the throat plate. Lock the throat plate.

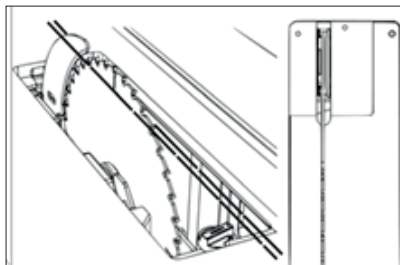

CAUTION: Make sure the riving knife is in-line with the blade. If it is not in line, please see the Adjustments Section.

### 6.7 Installing/removing the Blade

1. Unplug the table saw!
2. Remove any blade guards, riving knives, and the throat plate to access the blade.
3. Set the arbor tilt to 0 degrees and lock.
4. Raise saw to highest position.

5. Engage blade lock (red component).
  6. Remove the arbor nut and flange with arbor wrench.
  7. Remove or install blade.
- CAUTION: Make sure the teeth of the blade are facing the front of the saw as shown.

2. Remove all accessories



WARNING: MAKE SURE SAW IS UNPLUGGED. To access the blade remove all accessories around the blade, including riving knives, throat plates, ect.

3. Set arbor tilt to 0 and lock.

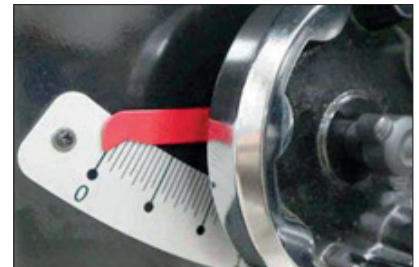

Set the arbor tilt to 0 degrees and lock the arbor to prevent it from moving when installing or removing blades.

4. Raise saw blade to highest position



5. Engage the blade lock



6. Remove arbor nut and flange



## 7. Adjustments

Your Laguna Tools machine comes fully adjusted from the factory, but it is good practice to double check these adjustments and make sure the tool is in safe operating condition.

### 7.1 Fence Adjustments

Fitting the fence:

You will need to fit the fence to the right side of the blade to use the table saw. You will need to fit the fence to the right side of the blade to use the table saw.

1. Unplug the table saw!
2. Hold fence with both hands, with cam lock up.
3. Place fence in fence guide
4. Check cam lock action, adjust if necessary.

2. Place fence in fence guide



While holding the fence and the cam lock, raise the cam lock to engage the open position. Insert the fence frame into the front rail.

3. Check Cam lock action

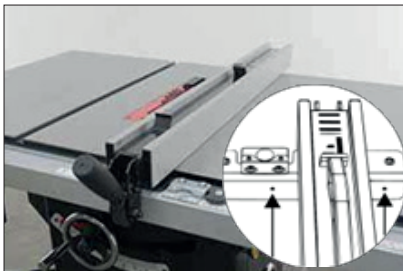

The fence can slide freely in any position to the right of the blade. If the fence does not lock, adjust both blade paralleling set screws.

Adjusting the Scale (rule):

The scale will need to be "zeroed" every time the fence guide is taken off the table or adjusted. The fence must be zeroed for accurate cuts when using the scale.

1. Unplug the table saw!
2. Position the fence up to blade.
3. Loosen the transparent viewport.
4. Adjust the view as needed.
5. Tighten the view screws.

Place fence in fence guide



**WARNING: MAKE SURE SAW IS UNPLUGGED.** With the blade in a high position, bring the fence close to — but not touching — the blade. Use a folded piece of paper between the blade and the fence to ensure good distance.

### Adjust the Viewport



Use a #2 Philips head driver to loosen (but do not remove) the transparent scale reader. Adjust the viewport as needed, tighten the screws. Note: If adjusting the viewport does not allow enough to zero the scale, see step 8 of general setup.

There are 2 magnifiers on the longitudinal ruler, which are used to adjust the width of the material according to whether you have set the aluminum profile vertically or horizontally on the longitudinal ruler.

Adjusting the Fence Glide Bushings:

You may need to adjust the height of the bushings on either side or rear of the fence. The fence should be between 1-3 mm off the table to prevent scratches.

1. Unplug the table saw!
2. Unlock the fence.
3. Use a hex key to adjust the front bushing height.
4. Use a wrench to adjust the rear bushing height.

### Front Bushings



To adjust the front bushings, use the included hex key to raise or lower the nylon bushings that make contact with the front fence rail.

### Rear Bushings



Adjusting the Fence to be parallel with the Blade: It is very important to only operate this saw with the blade parallel to the fence. Note: If this section does not help, please see the table adjustments section: Adjusting the Table to be Parallel with the Blade. The blade needs to be

parallel to the table (mitre slots) to effectively make the fence parallel to the blade.

1. Unplug the table saw!
2. Position the fence to access the fence adjustment screws.
3. Use a hex key to adjust each side
4. Make small increments and check

Use caution: It is not guaranteed that the fence will be parallel to the saw blade when shipped from factory. Make sure to make all required adjustments to make the fence parallel to the saw blade prior to operation.

### Position fence to access adj. screws

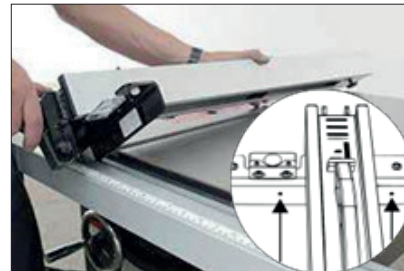

**WARNING: MAKE SURE SAW IS UNPLUGGED.** Take the fence out of position and flip it on its back side to access the cat screws that push the nylon supports in/out.

### Use a hex key to adjust



Use the included hex key to adjust the depth of each nylon support. Do small increments and check.

### 7.2 Table Adjustments

Adjusting the Table to be Parallel with the Blade: It is good practice to make sure that the table is always parallel to the blade by checking it often. You can do this with a combination square or with a dial indicator on an appropriate mount. Check the IGM website for these tools.

**Good**



Combination Square. Notice: This method may leave scratched.

## Better

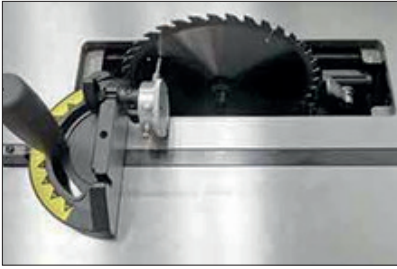

A dial indicator on a mitre gauge.

## Best

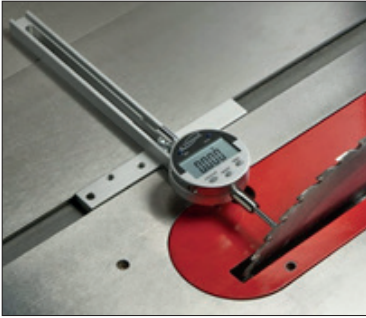

A dedicated saw dial indicator. Such as this one by 'lagging'.

1. Un-plug the tablesaw!
2. Take initial measurement.



**WARNING: MAKE SURE SAW IS UNPLUGGED.** With the throat plate and all attachments removed, raise the blade to the highest position at 90 degrees with the table. Take an initial measurement about 1 cm from the ground edge of the blade as shown.

3. Take relative measurement



Keep the mitre gauge against the left rail and slowly move across the blade. Take the second measurement and compare with the initial measurement. Adjust the table to compensate false measurements. There are 3 bolts to loosen prior to adjusting the table, see step 4.

4. Loosen the three table fastener bolts.
5. Adjust as needed.

## Loosen Table Bolts

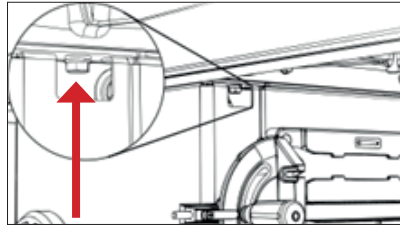

Locate and loosen right side table to cabinet bolt (above the tool holder).

## Loosen Table Bolts

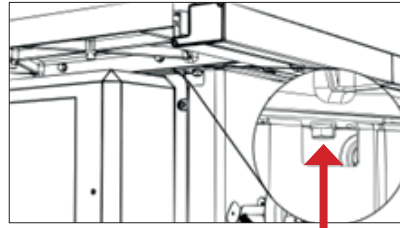

Locate and loosen left side table to cabinet bolt (above the motor cover).

## Loosen Table Bolts

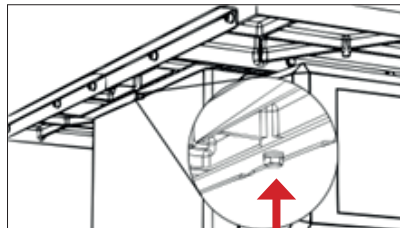

Locate and adjust the rear table to cabinet bolt.

Adjusting or Installing Extension Wings: (may be pre-installed):

To install or remove the extension wings, an advised method is provided. This method makes it easy to make the extension wings flat with the table but requires the use of two ridged supports and four clamps.

1. Unplug the table saw!
2. Clamp supports to table.
3. Place extension wing on supports.
4. Join or adjust the wing with supplied bolts.

Note: The clamps may scratch the tabletop! Use a cloth or soft wood between the clamp and the iron surfaces.

2. Take initial measurement

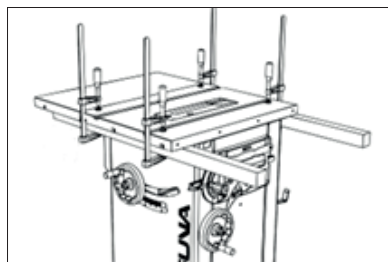

**WARNING: MAKE SURE SAW IS UNPLUGGED.** Clamp two wooden supports to the underside of the table saw as shown. Straight 2x4 lumber will work

## 3. Take relative measurement

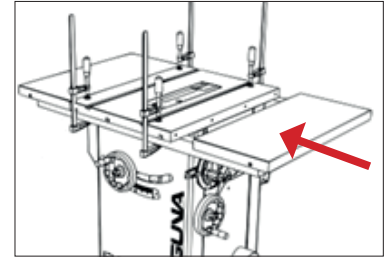

Place the extension wing on the supports and place into position.

## 4. Join or adjust wing

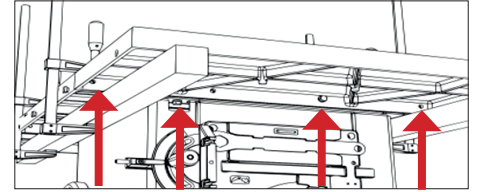

You will need (4) m10 bolts and (4) washers to fasten each extension wing to the table top. Be sure to align the extension wing to the table top prior to tightening the bolts.

## 7.3 Arbor and Tilt Adjustments

### Adjusting the Blade Tilt Limits

You can check the arbor (blade) tilt limits with an angle finder or 45-degree triangle. If these limits are not within 0 degrees and 45 degrees, use the following steps to adjust.

1. Unplug the table saw!
2. Remove the motor cover.
3. Remove the tool storage cover.
4. Locate tilt adjustment screws.
5. Adjust as needed.
6. Adjust the scale and indicator as needed.

Use caution: From the factory, the tilt limits are pre-set to 0 and 45 degrees tilt to the left. Adjusting this limit will slightly alter that amount which may cause throat plate or fence to interfere. Adjusting these limits should only be done to set the tilt limits to 0 and 45 degrees.

2. Remove motor cover

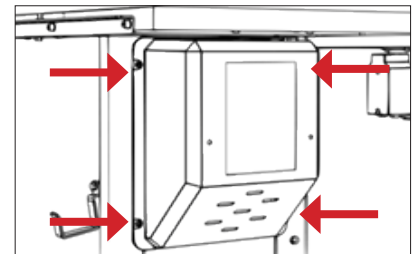

**WARNING: MAKE SURE SAW IS UNPLUGGED.**

To access the left side tilt limit adjustment screw, remove the motor housing cover using a #2 Phillips head driver. There are 4 screws in total holding on the motor cover.

3. Remove tool storage cover

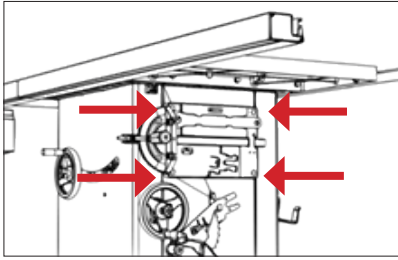

To access the right-side tilt adjustment screw, remove the tool storage using a #2 Philips head driver. There are 4 screws in total holding on the tool storage box.

4. Locate Tilt Adjustment

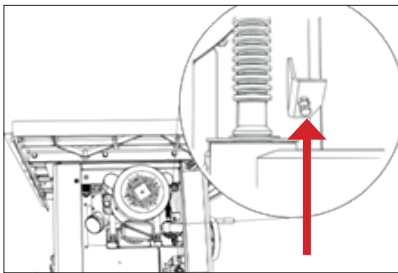

Locate the tilt adjustment screw. Screw it in to expand the tilt range slightly.

5. Adjust as needed

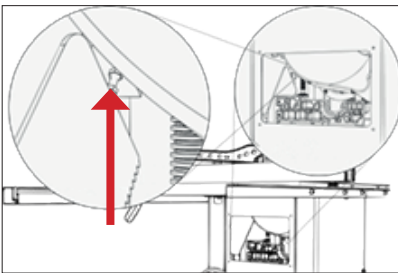

Locate the tilt adjustment screw. Screw it in to expand the tilt range slightly.

6. Adjust scale (if needed)

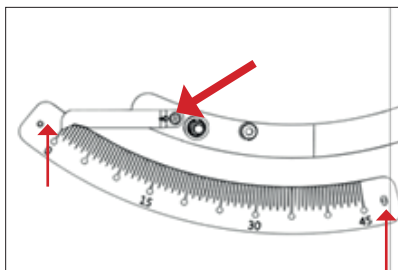

Adjust the scale and tilt indicator on the cabinet if needed.

**Adjusting the Belt:**

It is good practice to check the tension of the belt often to ensure that the saw is performing properly. If the table saw blade is slipping or is feeling underpowered, you may need to tighten the belt. To do so, follow the steps below.

1. Unplug the table saw!
2. Remove the motor cover.
3. Locate belt adjustment bolt.

4. Tighten or loosen with weight of motor.

Use Caution: DO NOT OVERTIGHTEN BELT! The weight of the motor is adequate to put enough tension on the belt. Only tight enough to prevent slippage.

**Remove the motor cover**

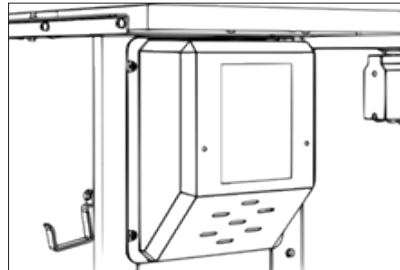

**WARNING: MAKE SURE SAW IS UNPLUGGED.**

To access the motor, remove the motor housing cover using a #2 Philips head driver. There are 4 screws in total holding on the motor cover.

**Locating Belt Adjustment bolt**

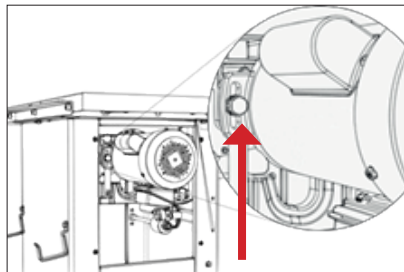

To adjust the belt, set blade to 0° on tilt scale, then raise or lower blade to approximately 2" above table. Loosen the belt adjustment bolt. With the bolt loose, Raise or lower the motor so that the belt is tight.

**Changing the belt:**

1. Unplug the table saw!
2. Remove all throatplates, blades, and blade accessories.
3. Remove the motor cover.
4. Remove the dust shroud.
5. Loosen the Belt adjustment bolt and loosen belt by raising motor.
6. Remove belt. NOTE: you may need to lower the arbor height to access the belt.
7. Replace belt.

Use Caution: DO NOT OVERTIGHTEN BELT! The weight of the motor is adequate to put enough tension on the belt. Only tight enough to prevent slippage.

**Belt Adjustment bolt**

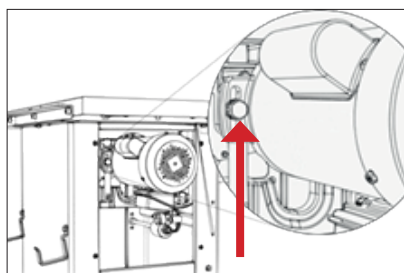

**WARNING: MAKE SURE SAW IS UNPLUGGED. NOTICE: The drawing shown is with the top of the table removed. AVOID**

removing the table top. The belt can easily be changed without removing the table top.

**Accessing the Belt**

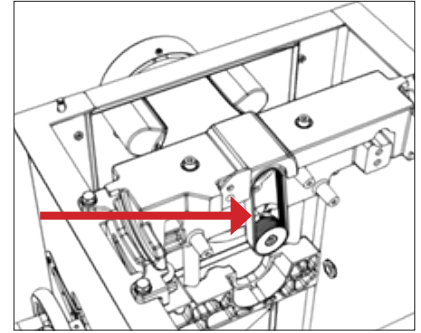

**7.4 Accessory Adjustments**

Insert Block Adjustments (For all Safety Accessories):

The Riving knife, blade guard, or splitter must be aligned with the blade to be used effectively. The riving knife should only be used with blades specified on the riving knife. To adjust the position of the blade safety attachments, relative to the saw blade: NOTE: if the cam action lever does not lock or is too hard to lock – adjust the nut on the back side of the cam action axil. You will need to remove the motor cover.

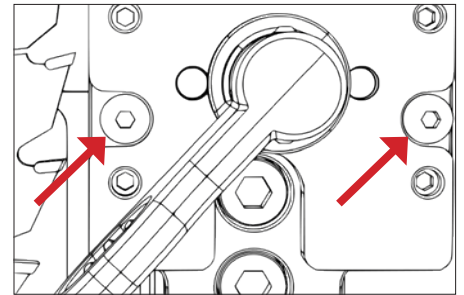

Loosen the two middle setting bolts. These two bolts fasten the assembly in-between the set screws and the arbor block.

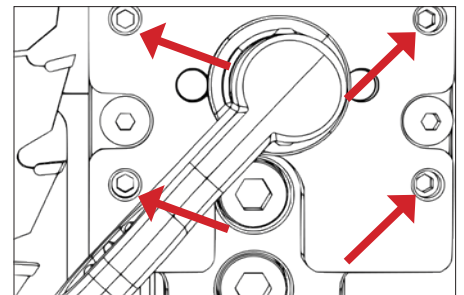

Adjust the set screws as needed to correct an out of align blade attachment. Do small adjustments and check.

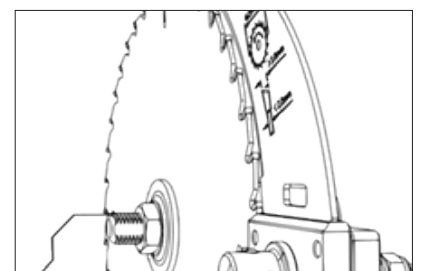

As Adjustments are made, the blade attachments will translate, not rotate, by design. This ensures that the workpiece will not get held up. **CHECK COMPONENTS BEFORE EVERY CUT.**

#### Riving Knife Adjustments::

After changing a saw blade, always check that the riving knife is correctly set!

The distance of the riving knife from the gear rim must be between 3 mm and 8 mm.

The highest point of the riving knife must be set at least 2mm beneath the topmost tooth.

The riving knife must be at least 0.2 mm thicker than the main saw blade.

Check that the saw blade clamping system is tight before operating the machine!

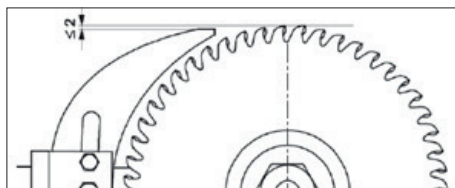
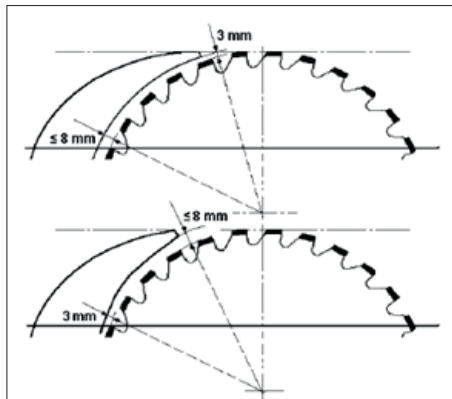

#### Dust Collector:

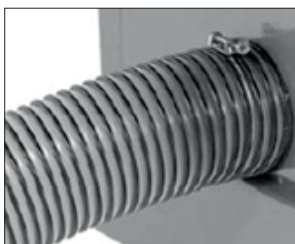

There is a 100 mm dust outlet located on the lower left of the saw cabinet allowing for the connection to a dust collection system (not included). Air current speed is 20m/s for vacuum suction dust emission index. When air current speed of dust collector device (in accordance with EN 12779:2004+ A1:2009) is not lower than 20m/s, ensure machine can be normal exhausted. User must wear dustproof mask.

1. Fit the 100 mm dust hose over the dust port, (not included) and secure in place with a hose clamp.
2. Make sure the hose could not come off.
3. Required air flow: 934 m<sup>3</sup>/h
4. Ensure pressure drop of each dust collector outlet carrying air current speed: 1500Pa
5. Wind speed of dust collector tube m/s: dry chips: 20m/s, water content is equal to 18% wet chips: 28m/s.

**Warning:** Always turn on the dust collector before starting the saw and stop the saw before turning off the dust collector.

**Note:** A tight fit is necessary for proper performance.

**Warning:** Always turn off the table saw before removing any cover of the machine.

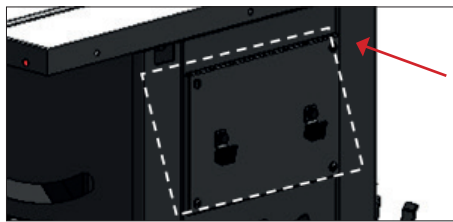

Remove the side cover, to clean and remove dust, debris from dust hood.

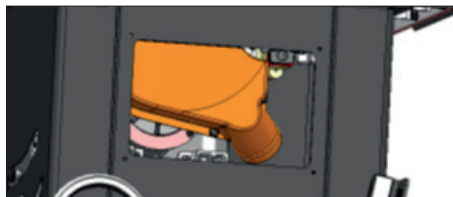

#### 7.5 Push block and push stick

A push block (Fig.2) and A push stick (Fig.3) must be used.

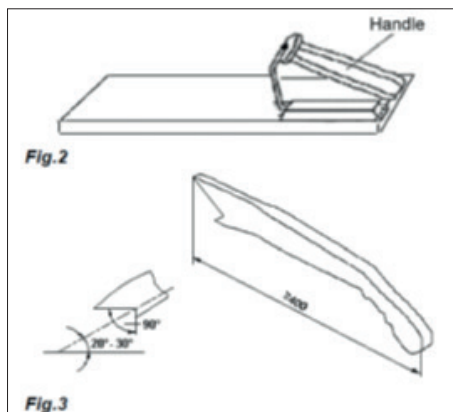

If the workpiece is less than 120mm, you must use the push stick to prevent your hands from getting too close to the saw blade. Push block must be used to cut narrow workpieces and, when necessary, to push the workpiece against the fence, a push block can be easily made by the operator as Pic.2.

**Warning:** Use only the push stick provided by the manufacturer or constructed in accordance with the instructions. This push stick provides sufficient distance of the hand from the saw blade.

**Warning:** Never use a damaged or cut push stick. A damaged push stick may break causing your hand to slip into the saw blade.

## 8. Type of Cut

**Warning:** Always wear safety glasses, a respirator and hearing protection when operating this machine.

**Note:** This saw is only designed to cut wood.

### 8.1 Ripping



Cutting a wood plank or sheet of plywood lengthwise to reduce its width is called "ripping". To rip stock, hold the work with both hands pushing it into the blade as well as firmly against the rip fence so that it is cut straight.

• Never rip or cut wood without using the fence or mitre gauge to guide it because the stock could kickback.

• Always use the blade guard and riving knife assembly when cutting wood. The riving knife prevents the saw "kerf" (the slit cut by the blade) from closing and binding the blade, which can overload and/or stall the motor or cause the blade to lift and eject the workpiece towards the front of the saw at very high speeds. The blade guard keeps your fingers away from the blade and also reduces the amount of sawdust flying free.

• Some jobs may require removing the riving knife along with the cover. Do not forget to put them back when you are done.

As you complete the rip, the wood will either remain on the table, tilt up to be caught on the end of the guard, or fall onto the floor (or outfeed table). The waste part of the stock remains on the table to be removed only after the saw is stopped (unless it is large enough for immediate safe removal).

If the work to be ripped is narrow, it is safer to use a push stick, rather than the hands, to feed it into the blade. Push sticks with non-slip grippers can be purchased, but a shop-made one works just as well. When ripping extremely narrow stock that may not clear the width of the blade guard, or very thin material such as panelling, which may slip between the underside of the fence and the table surface, a strip of wood as an auxiliary guide can be attached to the fence.

**WARNING:** Keep the blade guard installed and in the down position. Failure to do this could result in serious personal injury or death.

**WARNING:** Never reach in towards the blade while the blade is still spinning! whenever a rip cut is completed, turn off the saw and wait for the blade to come to a complete stop before reaching in to remove the workpiece or the waste material.

### 8.2 Bevel Ripping

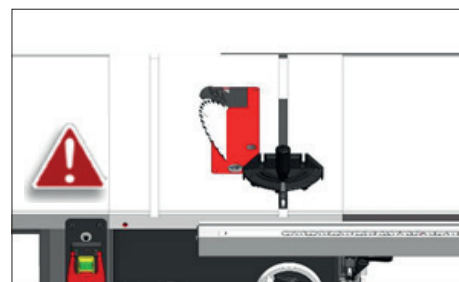

Bevel ripping is performed the same as ripping but with the saw blade set to an angle not perpendicular with the table surface. To tilt the blade to the left, anywhere between 0° and 45°. This is used most often when cutting bevels, compound mitres or chamfers.

After changing the bevel angle verify the alignment of the guard and splitter; make sure there is clearance with the saw blade.

#### Digital reading calibration

**Step 1: Set the wheel perpendicular to the work table on the scale is 0°, press ZERO to reset, 0.0 will be displayed..**

**Step 2: Turn the cast iron wheel to set 45°, press and hold the SET button.**

**Step 3: While holding SET, press and hold ZERO for 3 seconds.**

**When the ZERO button is released, 45° is displayed**

#### 8.3 Ripping small workpieces

Do not attempt rip cuts if the work piece is too small, as this will oblige you to place your hands too close to the blade and put you at serious risk of injury. When ripping narrower widths; use a push block or a push stick in order to avoid placing hands near the blade.

#### 8.4 Cross cutting

Cutting against the grain, to shorten the length of a board is crosscutting. With some smaller sized and rectangular pieces, you often have the choice of ripping or crosscutting. Always use the mitre gauge, when crosscutting; never cut a piece unsupported. The mitre gauge may be used in either slot, but most operators prefer the left groove for typical work. When the blade is tilted for bevel cutting, use the table slot that does not cause interference with your hand or the saw blade guard.

To begin crosscutting, place the work on the mitre gauge and, with the motor OFF, slide it up close to the blade to align the outer edges of the teeth with your cut mark (see pic).

Keep a firm grip as you pull the mitre gauge and the wood back away from the blade. Lower the blade guard, turn on the saw and make the cut. When the work is cut through, move one or both cut pieces.

#### 8.5 Angle ruler setting

Stiffness in the groove - for greater rigidity of the angle ruler in the table groove, there are 2 adjusting screws in the longitudinal profile of the angle ruler. For greater rigidity in the table groove, simply tighten the screws more (the more screws you screw into the profile, the greater the rigidity). For less rigidity, just loosen the screws.

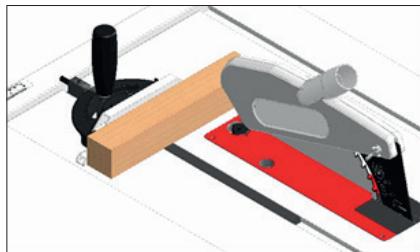

Warning: When cross-cutting round stock it is necessary to secure the workpiece against rotation by using a suitable jig.

#### 8.5 Bevel cross cutting

This procedure is the same as cross cutting except that the blade is set to an angle other than 0. After changing the bevel angle, verify

the alignment of the guard and splitter and verify that there is clearance with the saw blade.

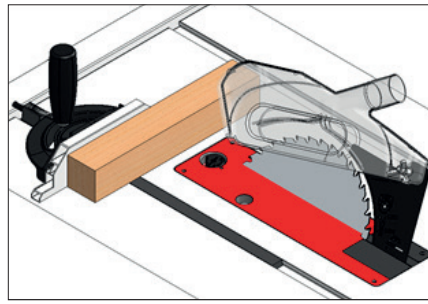

#### 8.6 Mitre cuts

This operation is the same as cross cutting, except the mitre gauge is set to an angle. Hold the work piece firmly against the mitre gauge and feed the workpiece slowly into the blade to prevent it from moving during the cut.

#### Ruler settings

Setting the cutting angle on the ruler - the angle ruler can be set to + 60° - -60°. By releasing the ruler handle, you can set the desired cutting angle by pulling and turning the control knob on the front of the ruler. Notches are prepared in the profile for more used angles.

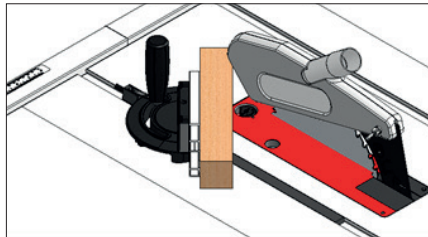

### 9. Maintenance

To keep your Laguna Tools machine in top performance for many years please follow this maintenance schedule and refer to any instructions.

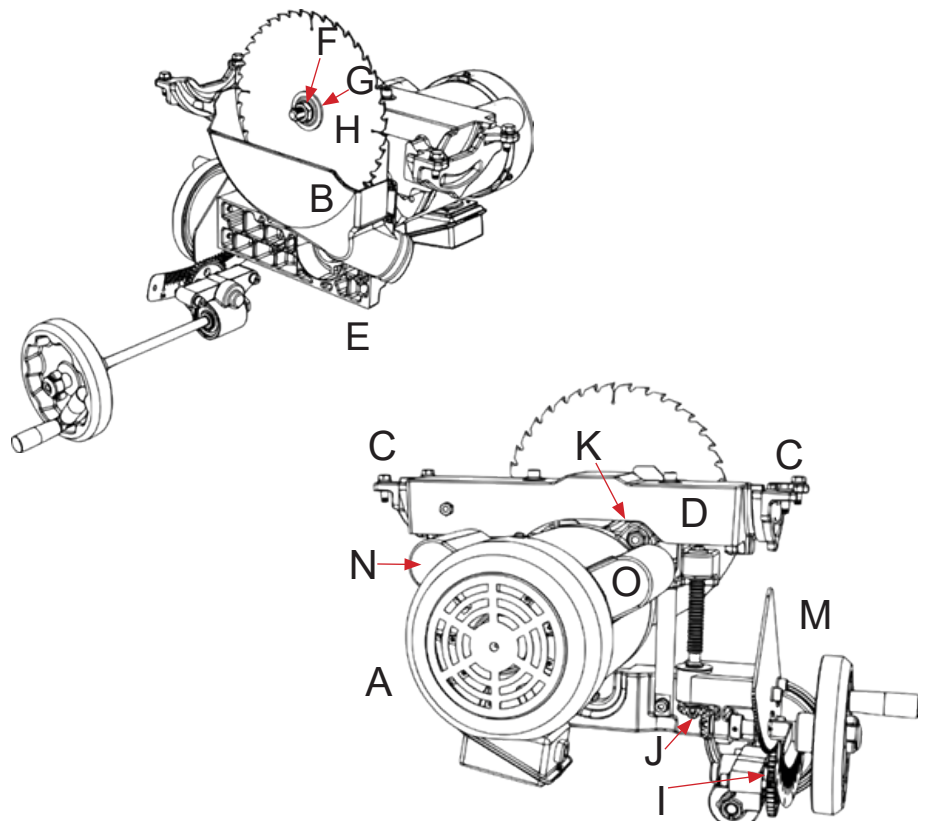

#### Daily Check:

- Loose mounting bolts
- Damaged saw blade
- Damaged riving knives, splitters, or blade guards
- Worn or damaged wires
- Any other unsafe condition

#### Weekly Maintenance:

- Clean table surface and mitre slot grooves
- Clean and protect cast-iron table
- Clean rip fence

#### Monthly Maintenance:

- Clean/vacuum dust buildup from inside cabinet and off motors.
- Check/replace belt for proper tension, damage or wear.

#### Every 6–12 Months:

- Lubricate trunnion slides.
- Lubricate worm gear.
- Lubricate leadscrew.
- Lubricate gearing and gearboxes.

#### 9.1 Internal Components Map

- A. Motor
- B. Dust Shroud
- C. Trunnion Slides (Support)
- D. Upper Trunnion
- E. Lower Trunnion
- F. Arbor Nut
- G. Arbor Washer (Flange)
- H. Blade
- I. Tilt Gearing
- J. Height Gearing
- K. Belt (behind blade)
- L. Worm Screw
- M. Tilt Plate
- N. Start Capacitor (see spec sheet)
- O. Run Capacitor (see spec sheet)

## 10. Trouble-Shooting

<p><b>Machine will not start or continues to trip the breaker.</b></p> <p>Possible Causes</p> <ol style="list-style-type: none"> <li>1. Start capacitor at fault.</li> <li>2. Motor connection wired wrong.</li> <li>3. Wiring at fault.</li> <li>4. Motor Start/Stop switch at fault.</li> <li>5. Motor at fault.</li> <li>6. Run capacitor at fault.</li> <li>7. Wall circuit breaker tripped or at fault.</li> <li>8. Power supply switched OFF or at fault.</li> <li>9. Plug/receptacle at fault or wired incorrectly.</li> </ol>	<p>Possible Solution</p> <ol style="list-style-type: none"> <li>1. Test/replace if faulty.</li> <li>2. Correct motor wiring connections.</li> <li>3. Check/fix broken, disconnected, or corroded wires.</li> <li>4. Replace switch.</li> <li>5. Test/repair/replace.</li> <li>6. Test/replace if faulty.</li> <li>7. Ensure circuit size is correct/replace weak breaker.</li> <li>8. Ensure power supply is on/has correct voltage.</li> <li>9. Test wires and contacts; correct the wiring.</li> </ol>
<p><b>Machine is excessively loud or is experiencing excessive vibration.</b></p> <p>Possible Causes</p> <ol style="list-style-type: none"> <li>1. Motor or component loose</li> <li>2. Blade at fault</li> <li>3. Motor mount loose/broken</li> <li>4. Machine incorrectly mounted</li> <li>5. Arbor pulley loose</li> <li>6. Belts worn or loose</li> <li>7. Pulley loose or at fault</li> <li>8. Arbor bearings at fault</li> <li>9. Motor bearings at fault</li> </ol>	<p>Possible Solution</p> <ol style="list-style-type: none"> <li>1. Inspect/replace damaged bolts/nuts, and re-tighten with thread-locking fluid.</li> <li>2. Replace warped/bent blade; re-sharpen dull blade.</li> <li>3. Tighten/replace.</li> <li>4. Tighten mounting bolts; relocate/shim machine.</li> <li>5. Retighten/replace arbor pulley.</li> <li>6. Adjust tension of/replace belt</li> <li>7. Realign/replace shaft, pulley, setscrew, and key.</li> <li>8. Replace arbor housing bearings; replace arbor.</li> <li>9. Test by rotating shaft; grinding/loose shaft requires bearing replacement.</li> </ol>
<p><b>Machine trips the overload, or feels underpowered during operation.</b></p> <p>Possible Causes</p> <ol style="list-style-type: none"> <li>1. Feed rate/cutting speed too fast</li> <li>2. Workpiece material unsuitable for machine</li> <li>3. Pulley/sprocket slipping on shaft</li> <li>4. Motor bearings at fault</li> <li>5. Contactor at fault</li> <li>6. Motor overheated</li> <li>7. Workpiece crooked; fence not aligned</li> <li>8. Machine undersized for task; wrong blade</li> <li>9. Run capacitor at fault</li> <li>10. Belt is slipping from pulley</li> <li>11. Motor wired incorrectly</li> <li>12. Plug/receptacle at fault</li> <li>13. Motor at fault</li> </ol>	<p>Possible Solution</p> <ol style="list-style-type: none"> <li>1. Decrease feed rate/cutting speed.</li> <li>2. Only cut wood; ensure moisture is below 20%.</li> <li>3. Replace loose pulley/shaft.</li> <li>4. Test/repair/replace.</li> <li>5. Test for good contacts/correct wiring.</li> <li>6. Clean motor, let cool, and reduce workload.</li> <li>7. Straighten or replace workpiece; adjust fence.</li> <li>8. Use correct blade; reduce feed rate or depth of cut.</li> <li>9. Test all legs for power/replace if faulty.</li> <li>10. Adjust tension of/replace belt.</li> <li>11. Test/repair/replace.</li> <li>12. Wire motor correctly.</li> <li>13. Test/repair/replace.</li> </ol>

**WARNING:**

1. Wiring should only be done by professional electricians. Always make sure the machine is properly earthed.
2. All wirings in the cabinets should be protected against direct contact to at least IP2X when finishing electrical installation.
3. All exposed conductive parts should be connected to the protective bonding circuit.
4. Close and lock the door of cabinets.

**WARNING:**

1. Enough space around the machine and the cabinets should be kept in order to maintain conveniently.
2. The machine should be installed in a workshop with good illumination and ventilation.
3. Over-voltage protection device should be provided by end user on spot.



# Wiring Diagram: Fusion 2 230V

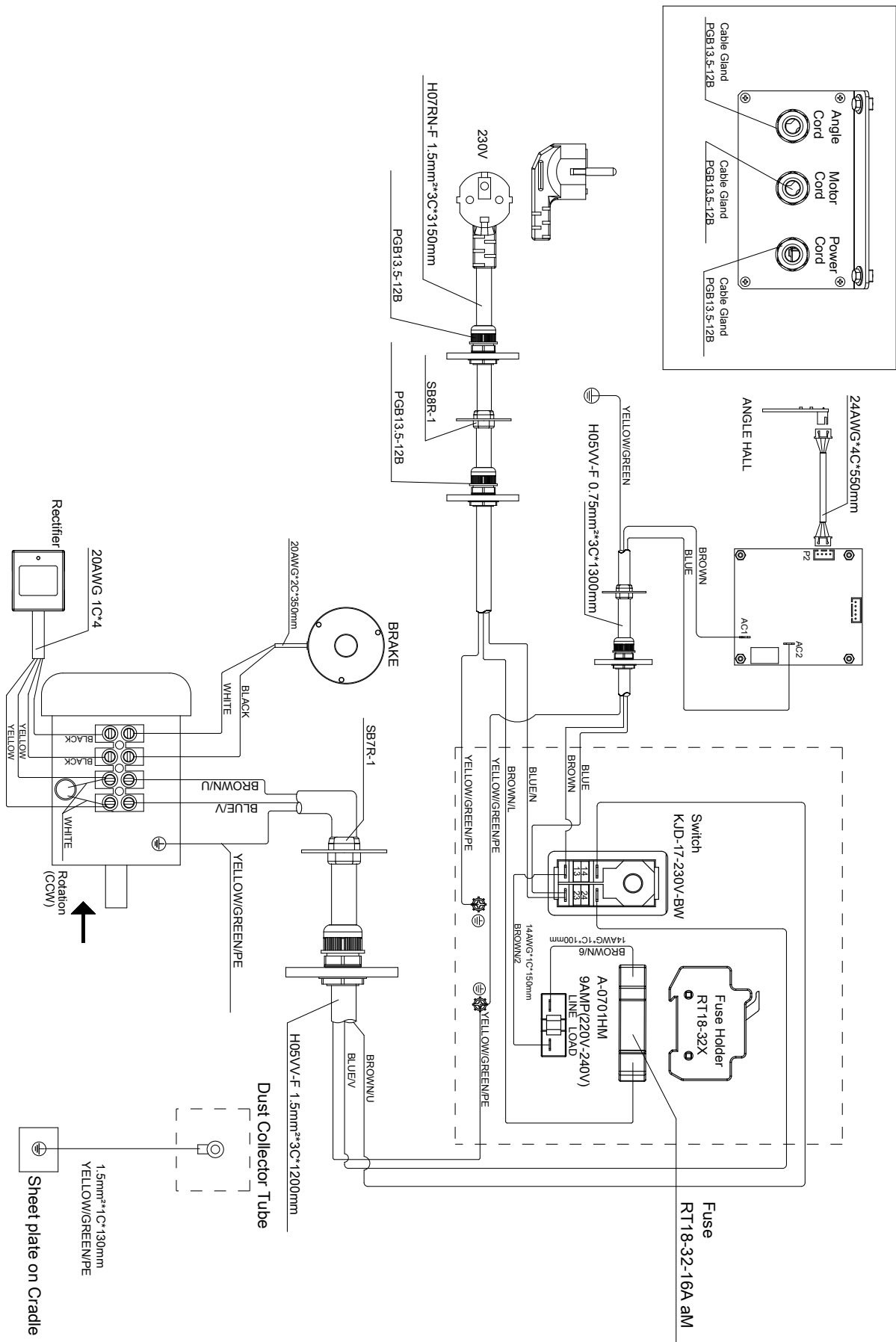

# Fence assembly

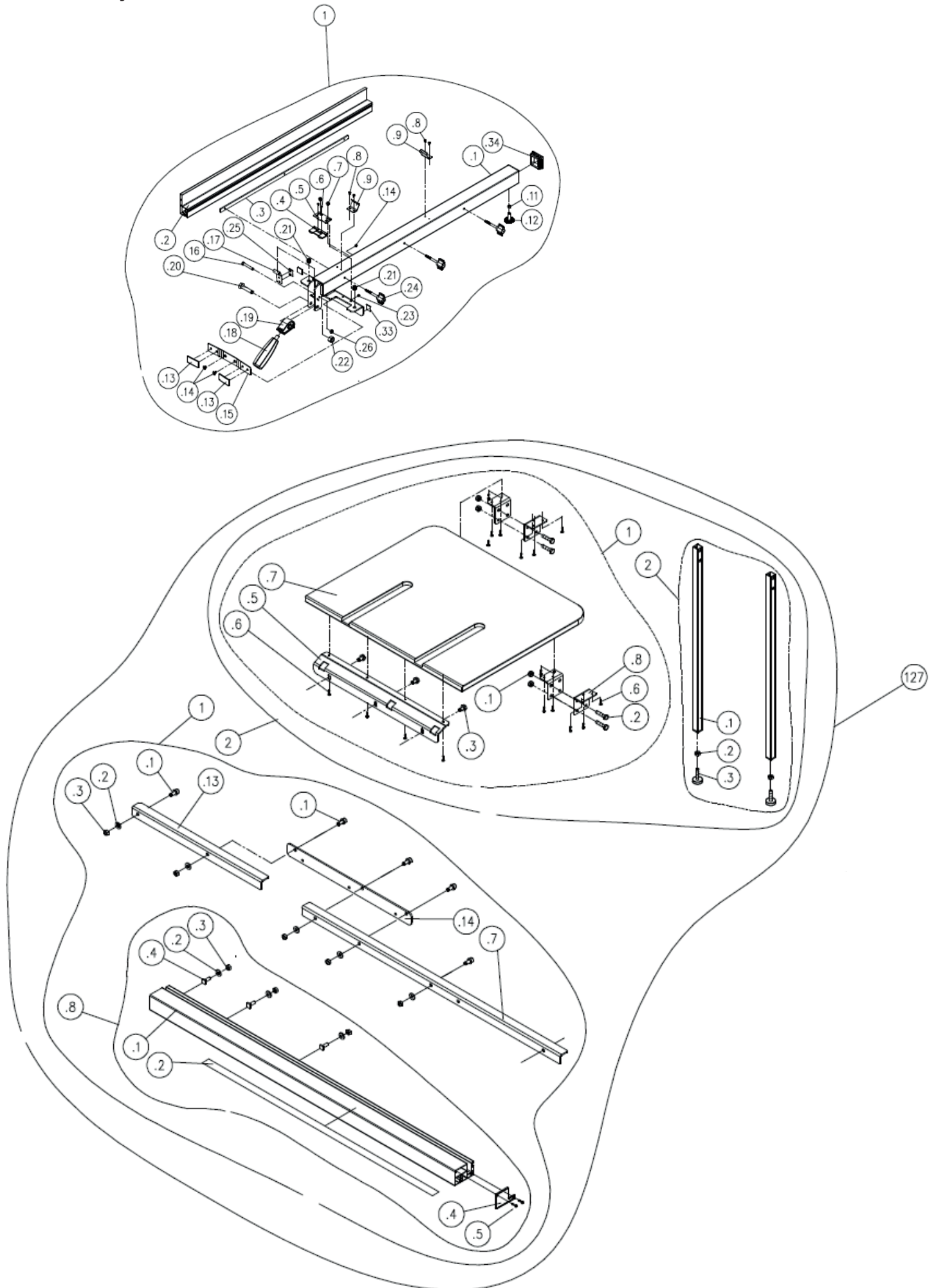

# Mitre gauge, blade guard

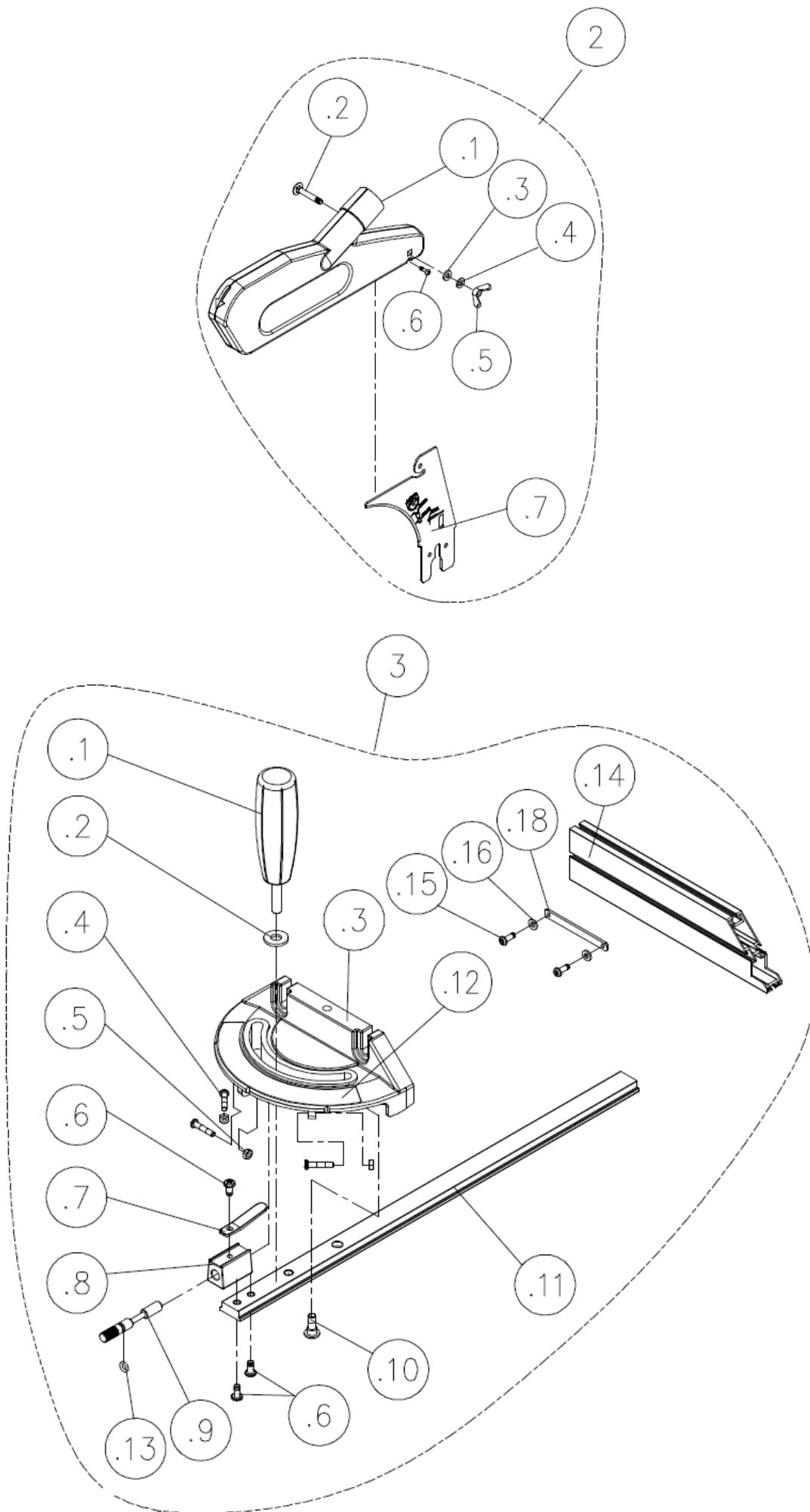

# Motor and trunnion

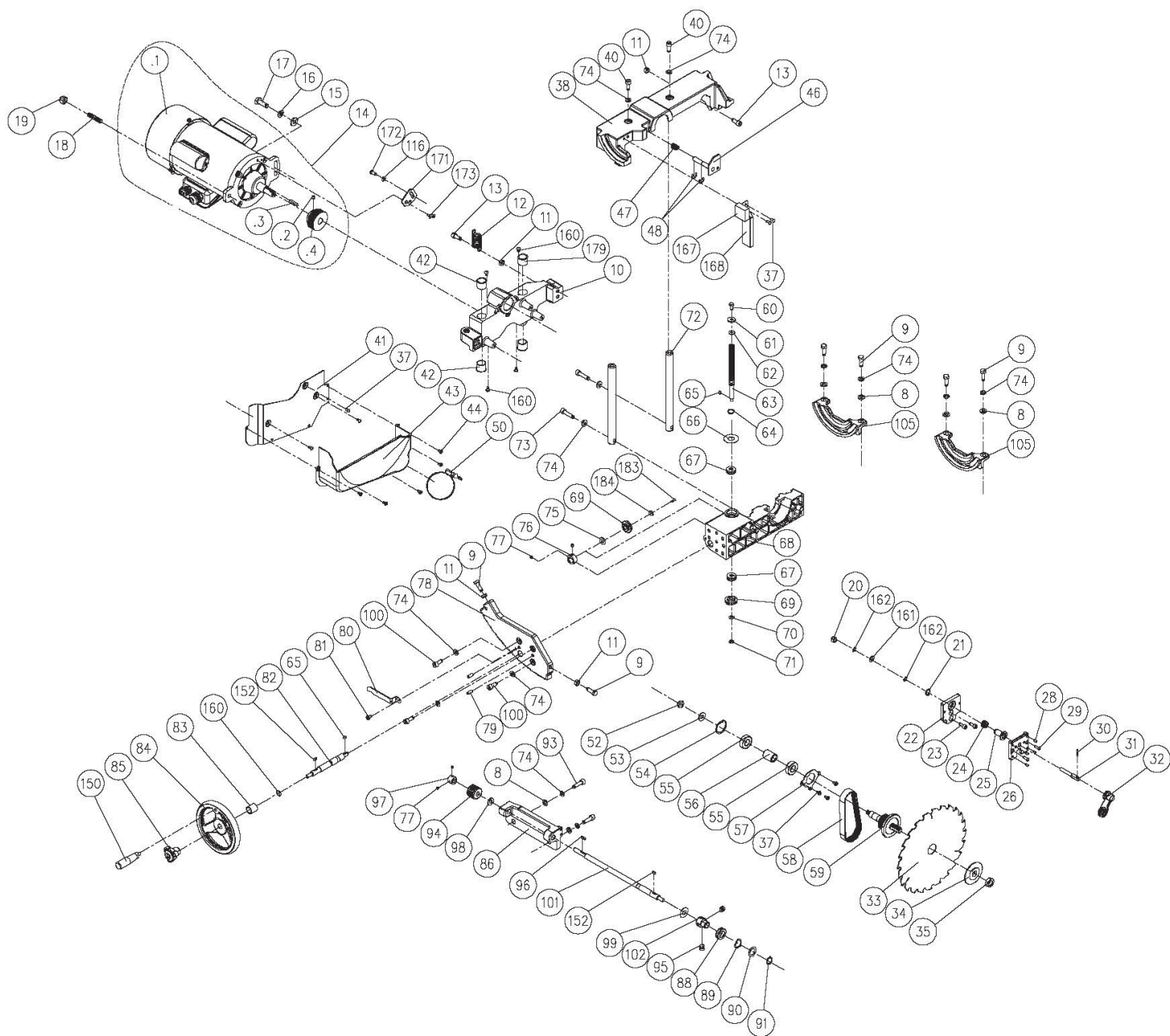

# Cabinet

